

J4

AUSTENITIC STAINLESS STEEL

General Characteristics:

J4 Grade is a chromium-manganese austenitic stainless steel with moderate amounts of copper, nickel and nitrogen. Balancing of the alloying elements produces an austenitic structure in the annealed condition.

Type J4 is suitable for replacing chromium-nickel grades 301, 304 in many applications. Lower cost manganese and nitrogen additions render this grade more economical while endowing it with good strength and high formability making it highly suitable for a wide variety of consumer and structural applications. Presence of copper in this steel reduces work hardening rate. The alloy is non-magnetic in annealed condition and like 304 becomes lightly magnetic after cold working due to formation of martensite. Thus J4 can display a wide range of mechanical strength depending on the degree of cold working, which is essential for certain structural applications.

Chemical Composition:

		%C	%Mn	%S	%P	%Si	%Ni	%Cr	%Cu	%N
J4	Min	-	8.5	-	-	-	1.0	15.0	1.5	-
	Max	0.10	10.0	0.01	0.08	0.75	2.0	16.0	2.0	0.20

Mechanical Properties:

Mechanical properties	UTS(MPa)	YS(MPa)	%EL	Hardness(HRB)
J4	650 min	325 min	40 min	100 max

Products available:

Hot Rolled Plates & Coil, Cold Rolled Coil & Sheets

Applications:

Deep drawn kitchen equipment, Furniture, Bins, Coal Bucket, Wear Plate Liners and Hoppers, Cookware & Serving Bowls, Window Channel Spacers etc.

Formability:

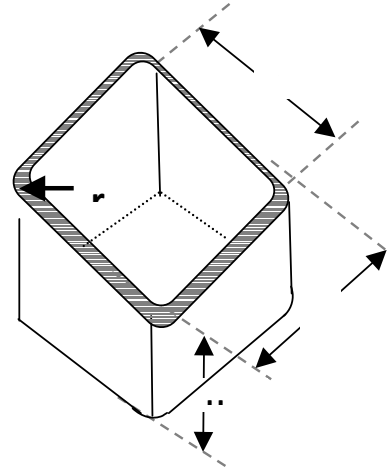
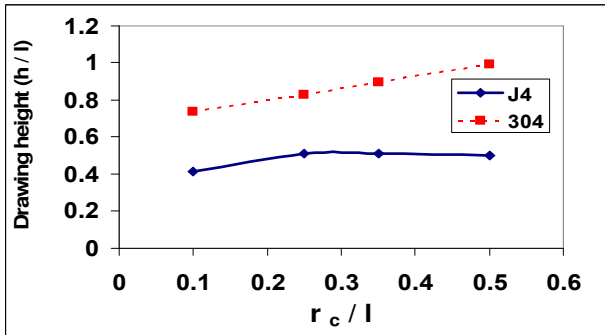
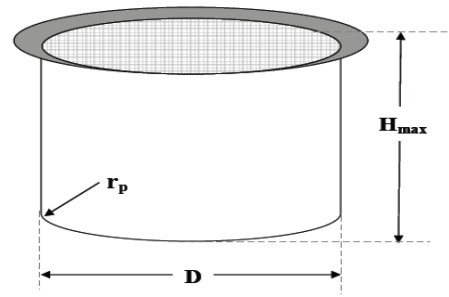
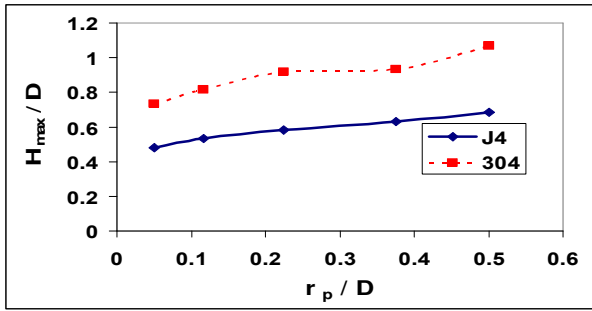

Grade	Limit Drawing Ratio (LDR)	Erichsen Cupping Value
304	2.1	13.1 mm
J4	1.7	11.5 mm

The technical information in this document describes typical characteristics and performance of the product. JSL and its affiliated companies do not accept responsibility for errors or for information which is found to be ambiguous and for the end use or application of products. Before using products customer should satisfy himself for their suitability. The information presented in this document is subject to change without notice.

J4 - 16Cr

AUSTENITIC STAINLESS STEEL

General Characteristics:

JSL J4-16Cr Grade is a chromium-manganese austenitic stainless steel with moderate amounts of copper, nickel and nitrogen. Balancing of the alloying elements produces an austenitic structure in the annealed condition.

This grade is similar to J4 with higher Cr for increased corrosion resistance.

Chemical Composition:

		%C	%Mn	%S	%P	%Si	%Ni	%Cr	%Cu	%N
J4-16Cr	Min	-	9.0	-	-	-	1.0	16.0	1.5	0.1
	Max	0.10	10.5	0.01	0.08	0.75	2.0	17.0	2.0	0.25

Mechanical Properties:

Mechanical properties J4-16Cr	UTS(MPa)	YS(MPa)	%EL	Hardness(HRB)
	650 min	325 min	40 min	100 max

Products available:

Hot Rolled Plates & Coil, Cold Rolled Coil & Sheets

Applications:

Wet Sliding mixing tanks, Furniture, Cookware & Serving Bowls,, structural frames for trailers, buses and rail cars, Window Channel Spacers, Deep drawn kitchen equipment.

Formability:

Grade	Limit Drawing Ratio (LDR)	Erichsen Cupping Value
304	2.1	13.1 mm
J4-16Cr	1.7	11.5 mm

The technical information in this document describes typical characteristics and performance of the product. JSL and its affiliated companies do not accept responsibility for errors or for information which is found to be ambiguous and for the end use or application of products. Before using products customer should satisfy himself for their suitability. The information presented in this document is subject to change without notice.

J201

AUSTENITIC STAINLESS STEEL

General Characteristics:

J201 type steels are lean nickel alloy austenitic stainless steel designed as a cost-effective solution for 301 grades in various applications.

Chemical Composition:

Designation		%C	%Mn	%S	%P	%Si	%Ni	%Cr	%Cu	%N
S20100 (J201)	Min	-	5.5	-	-	-	3.5	16.0	-	-
	Max	0.15	7.5	0.06	0.03	1.00	5.5	18.0	-	0.25
S20103 (J201L)	Min	-	5.5	-	-	-	3.5	16.0	-	0.1
	Max	0.03	7.5	0.045	0.015	0.75	5.5	17.5	-	0.25
S20153 (J201LN)	Min	-	6.4	-	-	-	4.0	16.0	-	0.1
	Max	0.03	7.5	0.045	0.015	0.75	5.0	17.5	1.0	0.25

Mechanical Properties:

Grade		Mechanical properties	YS (MPa) min	UTS (MPa) min	%EL min	Hardness (HRB) max
S20100	J201	201-a* ASTM A240	260	515	40	95
		201-b* ASTM A240	310	655	40	100
S20103	J201L	ASTM A240	260	655	40	95
S20153	J201LN	ASTM A240	310	655	45	100

*201-a and 201-b represent the rich and lean types of 201 respectively

Mechanical Properties of different tempers in 201LN:

J201LN can be provided in different tempers. The feasibility is subject to customer requirements.

Products available:

Hot Rolled & Cold Rolled coils and sheets

Applications:

- J201

Structural members, siding and roofing for railway cars and trailers and a variety of severely formed parts.

- J201L

Low temperature applications, heavy section services, Pots, Pans, Flatware, Counters, Counters, Sinks, Appliance components, Dishwashers, Ovens, Refrigerators, Hinges, Doors, Frames, Roll formed sections, spring clips

- J201LN

Welded constructions, structural uses and low temperature applications - Examples include sides & roofs of trains, liquefied gas storage vessels, structural members/chassis of railway rolling stock, trucks & trailers, coal handling equipment.

Corrosion Resistance:

J201 grades have comparable corrosion resistance to 301 grades.

The technical information in this document describes typical characteristics and performance of the product. JSL and its affiliated companies do not accept responsibility for errors or for information which is found to be ambiguous and for the end use or application of products. Before using products customer should satisfy himself for their suitability. The information presented in this document is subject to change without notice.

J202

AUSTENITIC STAINLESS STEEL

General Characteristics:

J202 is manganese alloyed austenitic stainless steel which is designed as a cost-effective solution to 302 grade with similar corrosion and mechanical properties.

Chemical Composition:

UNS		%C	%Mn	%S	%P	%Si	%Ni	%Cr	%N
S20200	Min	-	7.5	-	-	-	4.0	17.0	-
	Max	0.15	10.0	0.03	0.06	1.0	6.0	19.0	0.25

Mechanical Properties:

Mechanical properties	YS (MPa)	UTS (MPa)	%EL	Hardness (HRB)
ASTM A240	205 min	410 min	20 min	75-88 min

Products available:

Hot Rolled Plates & Coil, Cold Rolled Coil & Sheets

Applications:

Antennas, Refrigerator trays, Wire mesh, Cookware & Sinks, Hose Clamps, Frames, Industrial Strapping, Railway Rolling Stock, Furniture, Bins

Corrosion Resistance:

J202 grade is comparable to 304 grades in moderately corrosive media.

The technical information in this document describes typical characteristics and performance of the product. JSL and its affiliated companies do not accept responsibility for errors or for information which is found to be ambiguous and for the end use or application of products. Before using products customer should satisfy himself for their suitability. The information presented in this document is subject to change without notice.

J204

AUSTENITIC STAINLESS STEEL**General Characteristics:**

J204 is a chrome-manganese stainless steel belonging to 200 series of austenite stainless steel family with moderate amounts of nickel and nitrogen.

J204 is a new alloy that bridges the cost / property gap between 200 and 300 series stainless steel. Manganese as austenite former replaces a part of nickel and has beneficial effect on weldability. Consequently J204 has a higher annealed strength, similar corrosion resistance in a variety of mild corrosive media and similar formability & weldability in comparison with 304. It can replace Type 304 in numerous applications where higher strength, high formability and lower cost are required.

Chemical Composition Range : J204

	%C	%Mn	%S	%P	%Si	%Ni	%Cr	%Cu	%N
<i>Min</i>	-	5.0	-	-	-	2.0	17	-	0.1
<i>Max</i>	0.10	8.0	0.03	0.06	1.0	4.5	20.5	0.25	0.30

Mechanical Properties:

<i>Mechanical properties</i>	YS (MPa)	UTS (MPa)	%EL	Hardness(HRB)
	350 min	700 min	40 min	100 max

Products available:

Hot Rolled Plates & Coil, Cold Rolled Coil & Sheets

Applications:

Cookware & Sinks, Hose Clamps, Trailer, Frames, Industrial Strapping, Railway Rolling Stock.

Drawability:

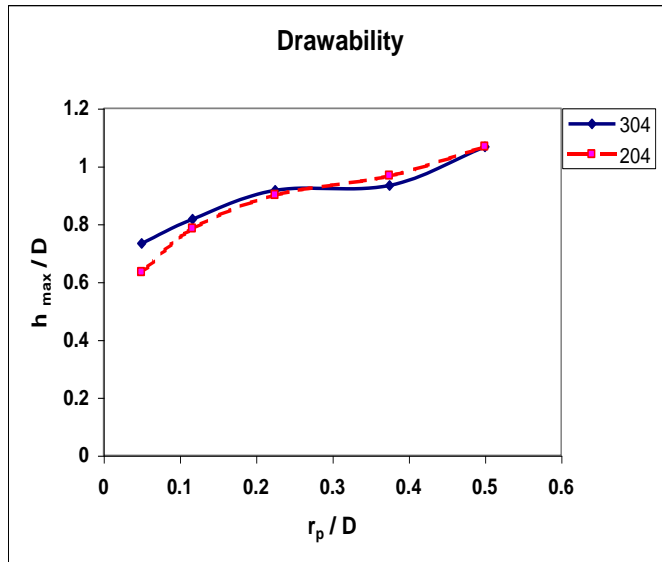

Cylinder Drawing Limit Ratio

Grade	Limiting Drawing Ratio [L.D.R]
J204	2.0
304	2.1

The technical information in this document describes typical characteristics and performance of the product. JSL and its affiliated companies do not accept responsibility for errors or for information which is found to be ambiguous and for the end use or application of products. Before using products customer should satisfy himself for their suitability. The information presented in this document is subject to change without notice.

J204Cu

AUSTENITIC STAINLESS STEEL

General Characteristics:

J204Cu is a chrome-manganese stainless steel belonging to 200 series of austenite stainless steel family with moderate amounts of nickel, copper and nitrogen. J204Cu is a new alloy that bridges the cost / property gap between 200 and 300 series stainless steel. It has better formability than J201 and 304 due to Cu addition which lowered the work hardening rate to provide cold working properties superior to 200 series stainless steel and similar to type 304. Copper improves corrosion resistance and stress corrosion cracking resistance in certain media. Nitrogen increases strength and pitting resistance of stainless steel. Manganese as austenite former replaces a part of nickel and has beneficial effect on weldability. Consequently J204Cu has a higher annealed strength, similar corrosion resistance in a variety of mild corrosive media and similar formability & weldability in comparison with 304. It can replace Type 304 in numerous applications where higher strength, high formability and lower cost are required.

Chemical Composition:

		%C	%Mn	%S	%P	%Si	%Ni	%Cr	%Cu	%N
J204Cu	Min	-	6.5	-	-	-	1.5	16	2.0	0.10
	Max	0.10	9.0	0.01	0.06	0.75	3.5	17.5	4.0	0.25

Mechanical Properties:

As per Product Standard	YS (MPa)	UTS (MPa)	%EL	Hardness (HRB)
	310 min	620 min	40 min	100 max

Products available:

Hot Rolled Plates & Coil, Cold Rolled Coil & Sheets

Applications:

As an effective cost alternative to type 201/304, J204Cu finds a wide range of applications. The major areas are:

- Catering and food process:** Deep drawn kitchenware , utensils, cookware , industrial kitchen equipment , flasks , milk cans , Ice and water dispensers , water filters ,domestic and commercial refrigerator outer body parts
- Consumer durables:** Sinks, Toasters, microwave ovens outer body parts, Baking ovens, Thermo wares, washing machines outer body parts, mobile case /parts

3. *Architecture, Building and construction: Handrails for staircase, elevators, escalators, internal panels, Door window frames, thermal window spacers*

4. *Transport (Automotive): Automotive hose clamps, safety belt anchors, truck and bus frames*

Corrosion Resistance:

Study of Leaching of iron, Chromium, Nickel and Copper in different food products when cooked in stainless steel coupons/cookware .Results are tabulated for eight food simulants and actual food media for Fe, Cr, Ni and Cu. The value of leached elements obtained through Atomic absorption spectrometry after keeping coupons of size 50mmx70mm and cookware 100mm diameter(made by deep drawn process) in 150 ml of simulant for boiling ~30 minutes. The solution was concentrated on water bath for removal of water content in simulant solution /food. The concentrate was subsequently made into ash by digesting in electrically heated muffle furnace. Ash solutions were prepared for each simulant by dissolving the respective ashes in 2% Nitric acid solution. The ashed solutions were then used for Atomic absorption spectrometry.

Food items	Grade	pH	Test coupons				Test cookware			
			Cu	Fe	Ni	Cr	Cu	Fe	Ni	Cr
3% Acetic acid	J204Cu	2.59	<0.1	0.1929	<0.1	<0.1	<0.1	0.1748	<0.1	<0.1
	304	2.59	<0.1	0.2104	<0.1	<0.1	<0.1	0.1764	<0.1	<0.1
3% Citric acid	J204Cu	2.82	<0.1	0.2565	<0.1	<0.1	<0.1	0.2675	<0.1	<0.1
	304	2.82	<0.1	0.3048	<0.1	<0.1	<0.1	0.2968	<0.1	<0.1
3% Lactic acid	J204Cu	2.80	0.11	1.1010	<0.1	<0.1	0.2337	1.194	<0.1	<0.1
	304	2.80	0.2092	1.5789	<0.1	<0.1	0.2296	0.9914	<0.1	<0.1
1% Tartaric acid	J204Cu	2.27	<0.1	0.7630	<0.1	<0.1	<0.2590	1.2754	<0.1	<0.1
	304	2.27	<0.1	0.8020	<0.1	<0.1	0.2396	1.0592	<0.1	<0.1
10% Ethanol	J204Cu	5.82	<0.1	0.5616	<0.1	<0.1	<0.1	0.7726	<0.1	<0.1
	304	5.82	<0.1	0.5002	<0.1	<0.1	<0.1	0.6780	<0.1	<0.1
Distilled water	J204Cu	6.8	<0.1	0.2891	<0.1	<0.1	<0.1	0.8743	<0.1	<0.1
	304	6.8	<0.1	0.8042	<0.1	<0.1	<0.1	0.2940	<0.1	<0.1
4%Common salt	J204Cu	6.1	<0.1	<0.1	<0.1	<0.1	<0.1	<0.1	<0.1	<0.1
	304	6.1	<0.1	<0.1	<0.1	<0.1	<0.1	<0.1	<0.1	<0.1
Refined sunflower oil	J204Cu	1.6	<0.1	<0.1	<0.1	<0.1	<0.1	0.11	<0.1	<0.1
	304	1.6	<0.1	<0.1	<0.1	<0.1	<0.1	<0.1	<0.1	<0.1
Tomato soup	J204Cu	3.6	<0.1	0.8697	<0.1	<0.1	<0.1	1.597	<0.1	<0.1
	304	3.6	<0.1	0.6219	<0.1	<0.1	<0.1	<0.1	<0.1	<0.1

**All values are in ppm (1 ppm=1 mg/Kg or µg/ml)*

Conclusion:

The leaching values of Chromium and Nickel are very low in all cases <0.1 ppm It was observed that there was no surface corrosion spot/rust marks in the tested coupons/cookware and no measurable weight loss when compared before and after the experiment.

Drawability and formability

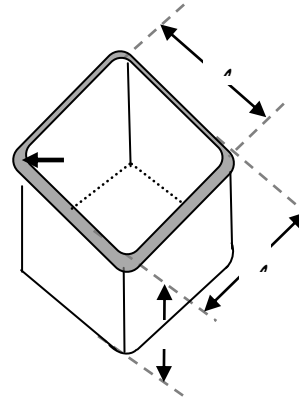
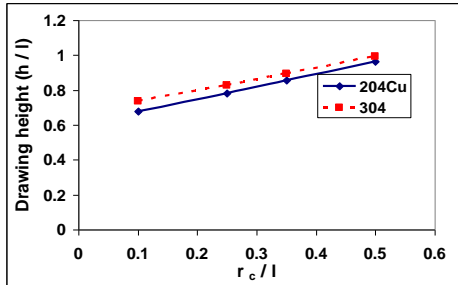
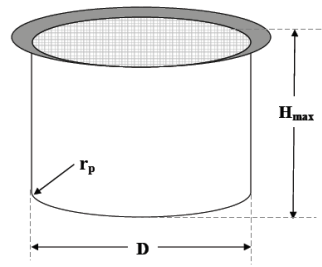
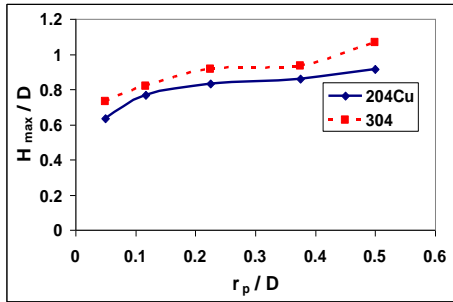

J204Cu can readily be cold rolled, cold drawn and formed in similar manner as Type 304. J204Cu can take upto 80% cold reduction without intermediate annealing.

Effect of cold work on Martensite formation: J204Cu will undergo magnetic transformation due to cold reduction. This magnetism is the result of forming deformation martensite with cold work. This martensite increases the strength, work hardening rate and abrasion resistance of alloy.

The technical information in this document describes typical characteristics and performance of the product. JSL and its affiliated companies do not accept responsibility for errors or for information which is found to be ambiguous and for the end use or application of products. Before using products customer should satisfy himself for their suitability. The information presented in this document is subject to change without notice.

J216L

AUSTENITIC STAINLESS STEEL

General Characteristics:

J216L is a Chrome-Nickel-Molybdenum austenitic stainless steel with manganese, nitrogen and copper, which offers a number of advantages over conventional 316L stainless steel. The corrosion resistance of this stainless steel is comparable to type 316L. This alloy has nearly 50% higher strength in annealed condition, higher elevated temperature strength coupled with better fatigue resistance. It can be cold rolled to significantly higher tensile strength while retaining a very low magnetic permeability.

A part of nickel & molybdenum of 316L is replaced by a combination of copper, manganese and nitrogen in this grade to retain austenitic structure and similar corrosion resistance. Synergy between molybdenum and nitrogen enhances the beneficial effect of molybdenum on corrosion resistance of the alloy. Simultaneous addition of molybdenum and copper improves corrosion resistance in sulphuric acid. Addition of nitrogen improves the resistance to pitting, crevice and intergranular resistance.

Such a combination of properties makes J216L highly suited for numerous applications in chemical, petrochemical, pulp, paper, oil & gas industries which currently use 316L.

Chemical Composition:

	%C	%Mn	%S	%P	%Si	%Ni	%Cr	%Cu	%Mo	%N
Min	-	6.0	-	-	-	6.0	16.0	1.5	1.5	0.15
Max	0.03	8.0	0.015	0.06	0.75	8.0	18.0	2.0	2.0	0.25

Mechanical Properties:

YS (MPa)	UTS (MPa)	%EL	Hardness (HRB)
310 min	520 min	40 min	100 max

Products available:

Hot Rolled Plates & Coil, Cold Rolled Coil & Sheets

Applications:

J216L is a cost-effective substitute for 316L in major applications.

Typical applications are architectural trims, marine exteriors, chemical processing equipment, food processing equipment, petroleum refining equipment, pharmaceuticals equipment, photographic equipment, pulp & paper processing equipment and textile finishing equipment.

➤ **PREN = Pitting Resistance Equivalent Number**

$$PREN = \%Cr + 3.3 Mo + 16N$$

➤ **MARC= Measure of Alloying for Resistance to Corrosion**

$$MARC = \%Cr + 3.3 Mo + 20C + 20N - 0.5Mn - 0.25Ni$$

Grade	MARC	PREN
J216L	21.57	25.018
316L	21.08	23.533

Fabrication:

Since J216L and 316L have comparable work hardening rate and sufficiently high ductility, the fabrication techniques are essentially similar. However on account of its higher strength, J216L requires more power to shear & form. The drilling speeds have to be lower compared to 316L for comparable tool life.

Weldability:

The alloy possesses good weldability like stainless steels of 300 series. Gas tungsten-arc and gas metal-arc techniques have been used for such grade. It can be welded to other stainless steels with conventional welding electrodes currently used. 316L electrodes have been used to weld this alloy.

The technical information in this document describes typical characteristics and performance of the product. JSL and its affiliated companies do not accept responsibility for errors or for information which is found to be ambiguous and for the end use or application of products. Before using products customer should satisfy himself for their suitability. The information presented in this document is subject to change without notice

JSL AUS

AUSTENITIC STAINLESS STEEL

General Characteristics:

JSL AUS is a chromium-manganese nickel austenitic stainless steel. Modest amount of nitrogen added to this steel results in higher annealed strength than AISI 304. However copper addition reduces work hardening rate to facilitate cold working /forming. The alloy is non-magnetic in annealed condition and like AISI 304 becomes mildly magnetic after cold working. Cold forming characteristics are superior to AISI 201 and 202 and the chemistry is so optimized as to achieve drawability similar to grade 304.

JSL AUS has been used for many applications where type AISI 304 was traditionally chosen. JSL AUS is relatively economical compared to AISI 304 having formability and weldability comparable to AISI 304 with corrosion resistance superior to AISI 430. Type JSL AUS is used both in fully annealed and in partially or fully cold rolled condition.

The mechanical properties vary considerably depending upon the amount of cold work introduced. The strength of JSL AUS is slightly higher than conventional austenitic steel such as 304. Considering its lower cost JSL AUS can replace conventional AISI 304 in a wide range of application.

Chemical Composition:

	%C	%Mn	%S	%P	%Si	%Ni	%Cr	%Cu	%N
Min	-	6.0	-	-	-	4.0	16.0	1.5	-
Max	0.08	8.0	0.01	0.07	0.75	6.0	18.0	2.0	0.10

Mechanical Properties:

Mechanical properties	YS (MPa)	UTS (MPa)	%EL	Hardness (HRB)
	205 min	550 min	40 min	95 max

Products available:

Hot Rolled Plates & Coil, Cold Rolled Coil & Sheets

Applications:

Deep-drawing utensils, ordnance components, water filters, storage, and milk cans, water tank, food industry, Automotive trim, Wheel caps, Wiper arms, Rims, Auto accessories.

Drawability:

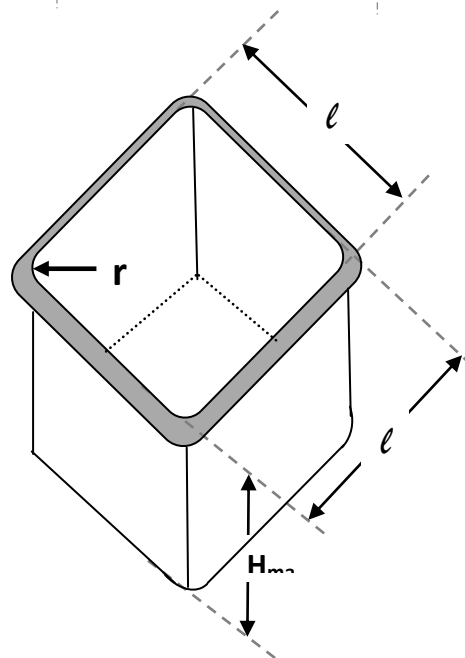
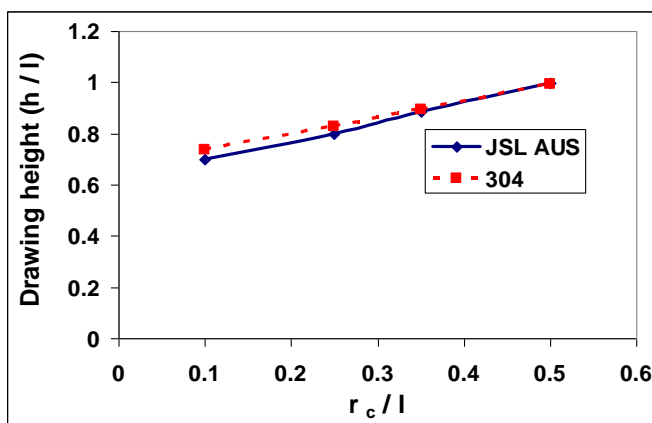
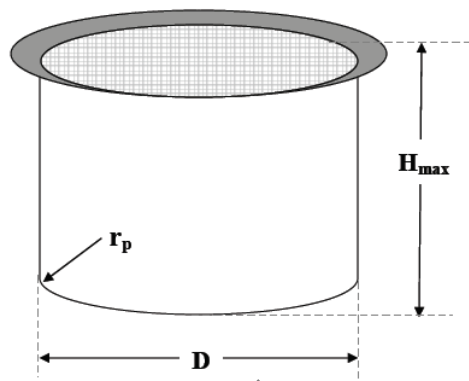
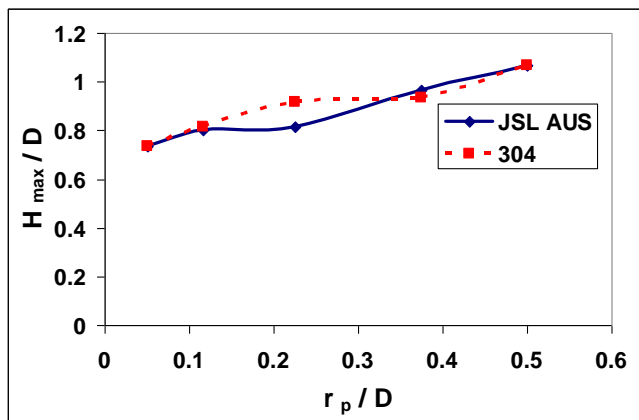

JSL AUS is very tough and ductile and readily amenable to deep drawing, bending, stretch forming and spinning. After heavy cold working, it is only mildly magnetic like 304.

Corrosion Resistance:

IGC testing as per ASTM A 262.	Corrosion Rate (mmpy)	
	Practice B	Boiling Ferric Sulfate 50% Sulphuric Acid
	Type JSL AUS	Type 304
	E	C
Practice C	65% Nitric Acid, Boiling	
	Type JSL AUS	Type 304
	C	C
Practice E	Copper/16% Copper Sulfate/Sulfuric Acid, Boiling	
	Type JSL AUS	Type 304
	No cracks	No cracks

Practice A	Oxalic Acid etch Test	
	Type JSL AUS	Type 304
	Step Structure	Step Structure

Classification based on Fontana , Corrosion Engineering. :

A< 0.02 mmpy, B 0.02-0.1 mmpy, C 0.1-0.5 mmpy, D 0.5-1.0 mmpy ,E: >1-5 mmpy

Study of Leaching of iron, Chromium , Nickel and Copper in different food products when cooked in stainless steel coupons/cookware. Results are tabulated for eight food simulants and 3 actual food media for Fe, Cr, Ni and Cu.

	pH	Cu	Fe	Ni	Cr
Simulated food items					
3% Acetic acid	2.59	<0.1	0.1136	<0.1	<0.1
3% Citric acid	2.82	<0.1	0.2390	<0.1	<0.1
3% Lactic acid	2.8	<0.1	0.888	<0.1	<0.1
1% Tartaric acid	2.27	<0.1	0.8008	<0.1	<0.1
10% Ethanol	5.82	<0.1	0.8130	<0.1	<0.1
Distilled water	6.8	<0.1	0.1990	<0.1	<0.1
4% Common salt	6.1	<0.1	<0.1	<0.1	<0.1
Refined sunflower oil	1.6	<0.1	<0.1	<0.1	<0.1
Actual Food Items					
Tomato soup	3.6	<0.1	0.3522	<0.1	<0.1

**All values are in ppm (1 ppm=1 mg/Kg or µg/ml)*

It was observed that there was no surface corrosion spot/rust marks in the tested coupons/cookware and no measurable weight loss when compared before and after the experiment.

Conclusion:- *The values of leaching in the tests conducted are within the limit for JSL AUS grade of stainless steel and will behave similar to type 304 during normal cooking.*

The technical information in this document describes typical characteristics and performance of the product. JSL and its affiliated companies do not accept responsibility for errors or for information which is found to be ambiguous and for the end use or application of products. Before using products customer should satisfy himself for their suitability. The information presented in this document is subject to change without notice.

JSLU DD

AUSTENITIC STAINLESS STEEL

General Characteristics:

JSLU DD is a Chromium-Manganese austenitic stainless steel with moderate amounts of copper and nitrogen and low amounts of Nickel. Balancing of the alloying elements produces a fully austenitic structure in annealed condition.

The presence of nickel and copper in this steel reduces work hardening rate and improves ductility and drawability. Lower cost manganese and nitrogen additions render this grade more economical while endowing it with good strength and high formability making it highly suitable for various consumer and structural applications.

Chemical Composition:

	%C	%Mn	%S	%P	%Si	%Ni	%Cr	%Cu	%N
Min	-	9.75	-	-	-	0.50	14.75	1.75	-
Max	0.15	11.0	0.015	0.10	0.75	0.80	16.25	2.50	0.2

Mechanical Properties:

Mechanical properties (Product standard Range)	YS (MPa)	UTS (MPa)	%EL	Hardness(HRB)
JSLU DD	350 min	700 min	40	100 max

Products available:

Hot Rolled Plates & Coil, Cold Rolled Coil & Sheets.

Applications:

*JSLU DD: Medium and Deep drawn utensils. Drawn and spun utensils.
Suitable for Deep Drawn Utensils upto 10 inch deep.*

Corrosion Resistance:

The corrosion behavior of Cr-Mn grade JSLU DD was comparable with AISI 304 stainless steels in a variety of mild and moderate chemical environments.

The technical information in this document describes typical characteristics and performance of the product. JSL and its affiliated companies do not accept responsibility for errors or for information which is found to be ambiguous and for the end use or application of products. Before using products customer should satisfy himself for their suitability. The information presented in this document is subject to change without notice.

JSLU SD

AUSTENITIC STAINLESS STEEL

General Characteristics:

JSLU SD is a Chromium-Manganese austenitic stainless steel with moderate amounts of copper and nitrogen and low amounts of Nickel. Balancing of the alloying elements produces a fully austenitic structure in annealed condition.

This stainless steel is endowed with good strength and moderate formability making it highly suitable cost effective grade for a wide variety of consumer and structural applications having shallow drawing.

Chemical Composition:

	%C	%Mn	%S	%P	%Si	%Ni	%Cr	%Cu	%N
Min	-	9.75	-	-	-	0.40	14.5	1.0	-
Max	0.15	11.0	0.015	0.1	0.75	0.75	16.0	1.5	0.2

Mechanical Properties:

Mechanical properties (Product standard Range)	YS (MPa)	UTS (MPa)	%EL	Hardness(HRB)
JSLU SD	350 min	700 min	40 min	100 max

Products available:

Hot Rolled Plates & Coil, Cold Rolled Coil & Sheets.

Applications:

JSLU SD: Tableware, Cutlery, Light and Medium drawn utensils, Drawn and spun utensils. Suitable for shallow drawn utensils upto 4 inch deep.

Corrosion Resistance:

The corrosion behavior of Cr-Mn grade JSLU SD is comparable with AISI 304 stainless steels in a variety of mild and moderate chemical environments.

The technical information in this document describes typical characteristics and performance of the product. JSL and its affiliated companies do not accept responsibility for errors or for information which is found to be ambiguous and for the end use or application of products. Before using products customer should satisfy himself for their suitability. The information presented in this document is subject to change without notice.

JT

AUSTENITIC STAINLESS STEEL

General Characteristics:

JT is a cost effective austenitic stainless steel with high strength. It is used in conditions have moderate corrosion resistance. It is commonly used in pipes and tubes applications.

Chemical Composition:

	%C	%Mn	%S	%P	%Si	%Ni	%Cr	%Cu	%N
<i>Min</i>	-	9.75	-	-	-	0.40	14.0	0.40	-
<i>Max</i>	0.13	11.0	0.015	0.1	0.75	-	15.25	-	0.2

Mechanical Properties:

<i>Mechanical properties</i>	<i>UTS (MPa)</i>	<i>YS (MPa)</i>	<i>%EL</i>	<i>Hardness (HRB)</i>
<i>As per Product standard</i>	<i>700 min</i>	<i>350 min</i>	<i>40 min</i>	<i>100 max</i>

Products available:

Hot Rolled Plates & Coil, Cold Rolled Coil & Sheets

Applications:

Tubes

The technical information in this document describes typical characteristics and performance of the product. JSL and its affiliated companies do not accept responsibility for errors or for information which is found to be ambiguous and for the end use or application of products. Before using products customer should satisfy himself for their suitability. The information presented in this document is subject to change without notice.

X8CrMnN18

General Characteristics:

X8CrMnN18-18 is high alloyed austenitic stainless steel with high Chromium and Manganese content coupled with high Nitrogen to impart excellent range of strength and elongation in various hot rolled and cold rolled finishes.

Chemical Composition: DIN Specifications

	%C	%Mn	%S	%P	%Si	%Ni	%Cr	%N
Min	-	17.5	-	-	-	-	17.5	0.4
Max	0.12	20.0	0.03	0.06	1.0	1.0	20.0	0.7

Mechanical Properties: (Typical Values)

Thickness(mm)	Condition	YS (MPa) min	UTS (MPa) min	El% min	Hardness(HV) max
50	HR	550	830	52	320
20	HR	630	933	50	320
15	HR	790	960	45	325
8	HR	934	1064	34	362
7	HR	1032	1098	32	441
6	HR	1066	1157	26	441
5	HR	1092	1153	25	435
4	HR	1096	1100	21	386
3	HR	1150	1170	13	392
2	HR	1180	1180	10.5	390
4	35%CR	1340	1368	10	390
3	50%CR	1350	1400	8	420
3	25%CR	1300	1340	9	410
2	50%CR	1730	1780	4	460
2	35%CR	1538	1600	4	435

Charpy impact testing was carried out at 20degC and -40degC in 20mm and 50mm hot rolled samples.

Thickness	Charpy Impact energy at 20 deg.	Impact energy at -40 deg
20	287	265
50	280	271

Products available:

Hot Rolled Plates. Cold Rolled Sheets.

Applications:

This alloy was designed for armour applications due to its high impact resistance in ballistic testing.

Corrosion Resistance:

High Cr and Nitrogen contents enable superior corrosion resistance in this grade as compared to various high end grades like 316L.

The technical information in this document describes typical characteristics and performance of the product. JSL and its affiliated companies do not accept responsibility for errors or for information which is found to be ambiguous and for the end use or application of products. Before using products customer should satisfy himself for their suitability. The information presented in this document is subject to change without notice.